

<p>A</p>  <p>Ø6 x 12mm x20</p>	<p>B</p>  <p>x 10</p>	<p>C</p>  <p>Ø6 x 28mm x 19</p>
<p>D</p>  <p>x 19</p>	<p>E</p>  <p>x 1</p>	<p>H</p>  <p>Ø8 x 30mm x 6</p>

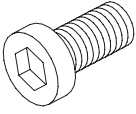

1

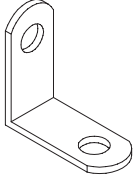
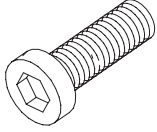
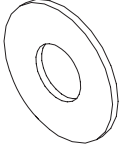
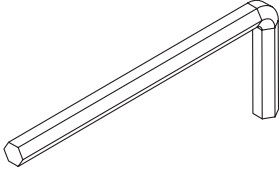
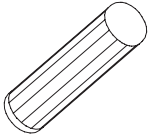
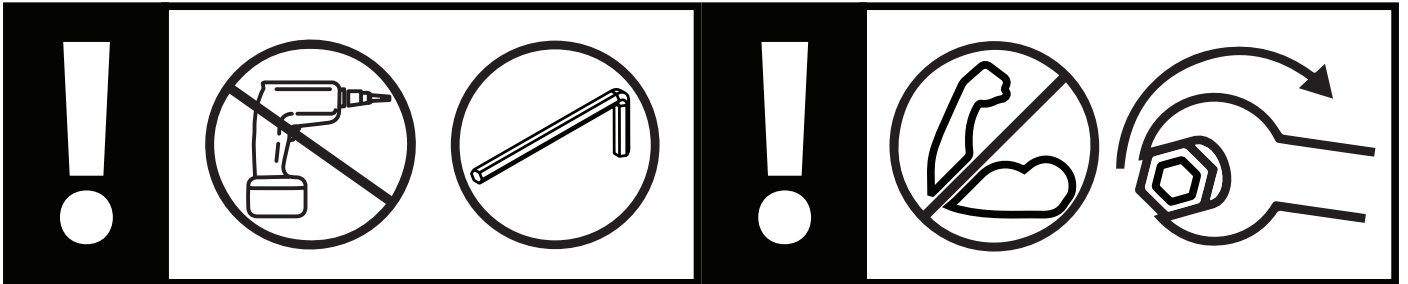
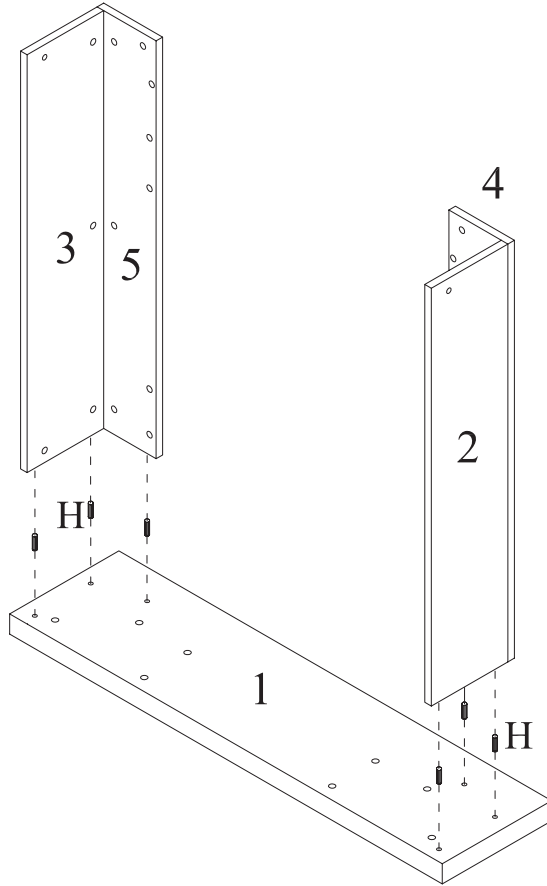

H



Ø8 x 30mm
x 6

2

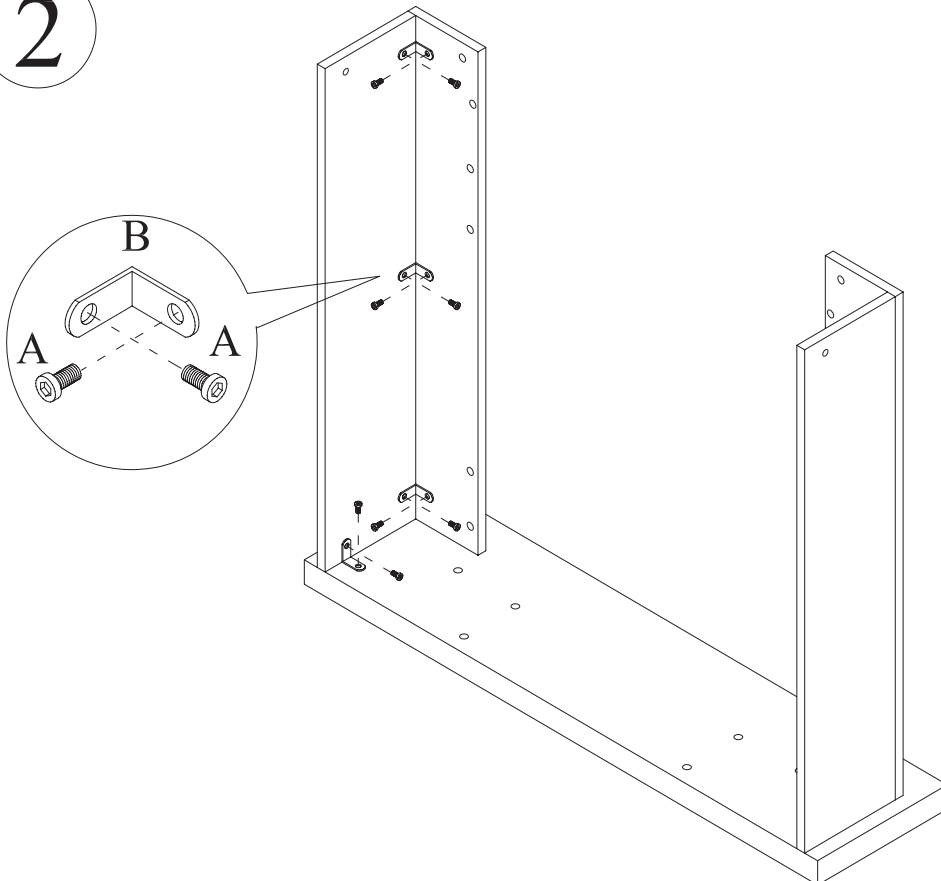

A



Ø6 x 12mm
x16

B

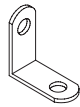

x 8

3

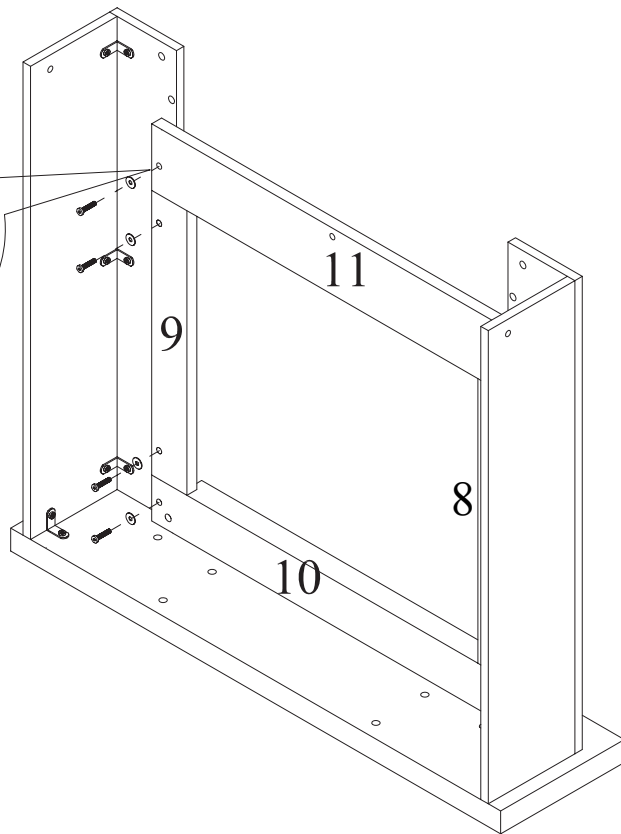
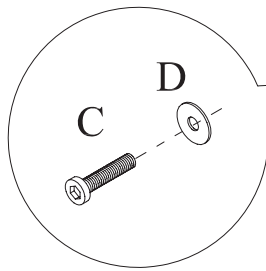

C
Ø6 x 28mm
x 8

D
x 8

4

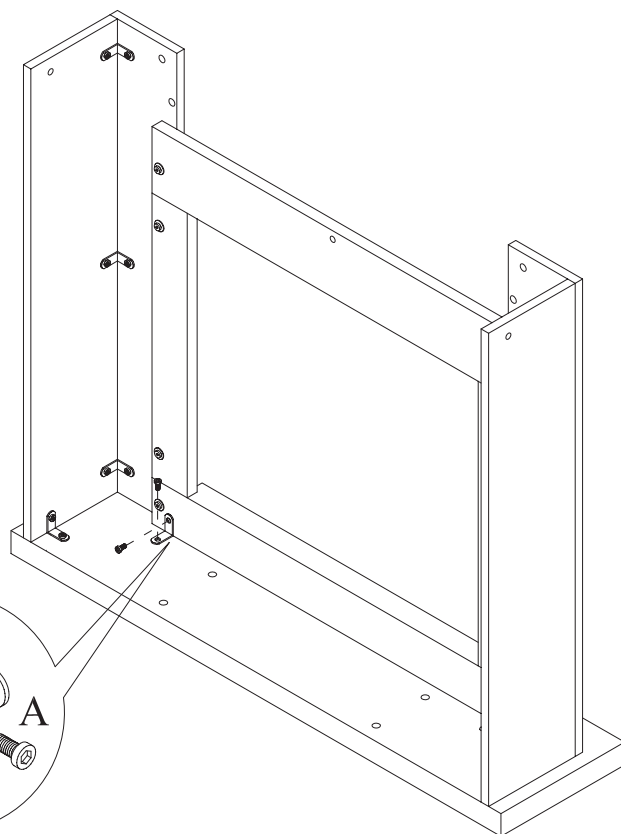
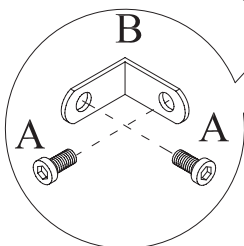

A
Ø6 x 12mm
x 4

B
x 2

5

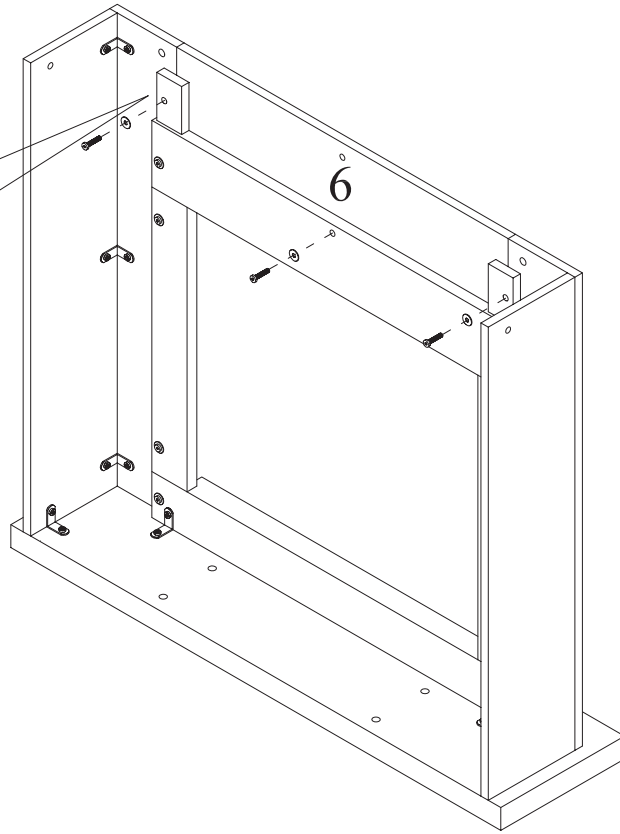
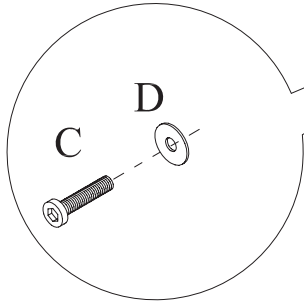

C
Ø6 x 28mm
x 3

D
x 3

6

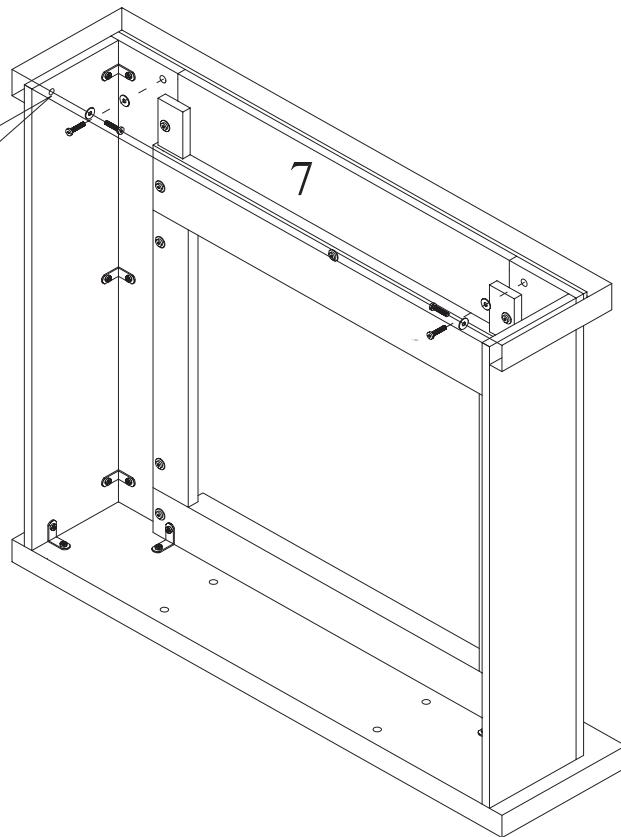
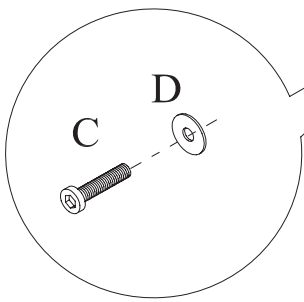

C
Ø6 x 28mm
x 4

D
x 4

7

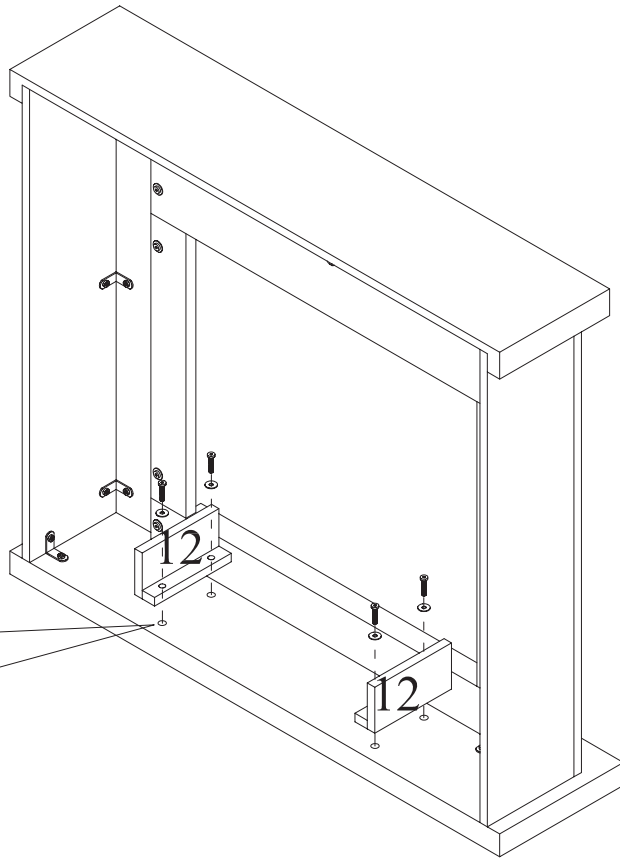

C
Ø6 x 28mm
x 4

D
x 4

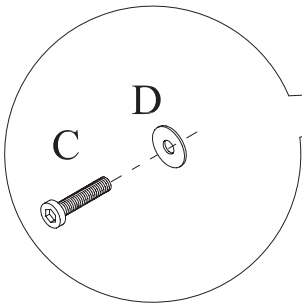

8

