

MANUAL ESPOO FLOOR



1. Packaging	page 3
2. Content of the Box	page 4
3. Safety	page 4
4. Positioning & Installation	page 5
5. Operating Instructions	page 7
6. Maintenance	page 9
7. Disposal & Recycling	page 10
8. Bioethanol	page 10
9. Symbols of Awareness	page 11

It is imperative that you read this manual before using the fireplace. Keep the manual in a safe place for further reference.

It is important that you read the installation and operation instructions and adhere to the safety measures described in this document.

Decoflame ApS cannot be held responsible for any damage caused as a result of non-adherence to these instructions.

Please keep the packaging of your fireplace in case it needed to be sent back to the factory.

1. PACKAGING

Upon receiving the fireplace, take notice of the following:

The fireplace can be packed in:

- 1) A cardboard box with polystyrene inside and placed on a pallet.
- 2) A wooden crate with polystyrene inside and with 50-100mm wooden support for easier handling with a fork- or pallet lift.

Damages of the packaging

Please check the state of the cardboard box or the wooden crate while the courier is still there for visible damages.

If any damages are visible on the packaging it is **EXTREMELY IMPORTANT** to write a report remark about them on the delivery note, in the presence of the courier. Afterwards it is very important to contact Decoflame immediately with the following documentation:

- 1) Photos of all 4 sides of the pallet or wooden crate / cardboard box.
- 2) A description and explanation of the damage.
- 3) A copy or a photo of the delivery note from the driver/courier with the written remark and tracking number.

Contact the courier company immediately and inform them about the damage. Please remember to inform the tracking number.

Hereinafter Decoflame will contact you within the following 3-5 working days.

When you remove the fireplace from the pallet or take it out of the box, please follow the instructions below carefully.

Unpacking the fireplace

Lift or drive the whole box or crate as close as possible to the place where the fireplace is going to be mounted or installed.

Open the wooden crate carefully without causing scratches or damages. Bend the metal fingers open using a screwdriver. Make sure that you slowly and carefully take out the fireplace and place it down on a flat surface without dropping it.

Please make sure that every item or part is wrapped out of the foam foil. If anything is missing, please contact Decoflame immediately or send an email describing the missing parts together with photos of the contents in the box.

It is very **IMPORTANT** to keep the wooden crate or the cardboard, in case the fireplace will need to be returned to Decoflame for service or repair. In the situation where the original packaging is not available anymore, Decoflame can send a new wooden crate. For further information about the costs, please contact Decoflame.

Damages of the Fireplace

If the packaging is not damaged and corresponding to the images sent by Decoflame with the tracking number, the wooden crate/cardboard box can be open.

If you notice any damage on the fireplace, the following information needs to be sent with Decoflame:

- 1) Photos of all 4 sides of the pallet / wooden crate AND the fireplace.
- 2) A description and explanation of the damage.
- 3) A copy or a photo of the delivery note from the courier with the written remark and tracking number.
- 4) Contact the courier and inform them about the damages. Please remember to inform the tracking number.
- 5) Contact Decoflame by email and enclose all documents according points 1-4. Please remember to inform the tracking number and order number - up to 5 digits (The order number can be found on the delivery note from Decoflame or from your retailer).

The deadline for claiming transport damages is maximum 3 working days from the date of delivery.

Contact information at Decoflame:

Decoflame ApS
Vang Mark 2
9380 Vestbjerg
Denmark
Tel. +45 96 30 48 00

(Opening hours: Mon-Thur. 08:00-16:00 and Fri. 08:00-15:30 Danish Time)

Email: logistics@decoflame.dk

Attention line in the email: Order number (Up to 5 digits).

Decoflame refers to The Generals Sales and Delivery Terms.

If any questions or doubts, please contact Decoflame or local retailer.

DO NOT

1	DO NOT open the box or wooden crate with sharp objects.
2	DO NOT flip the cardboard box or wooden crate on the sides or on the top. The arrow stickers MUST be followed carefully.
3	DO NOT use a hammer or other hard objects.
4	DO NOT use saws or other similar objects.
5	DO NOT smoke near the fireplace as there might be bioethanol
6	DO NOT lift in the parts which are sensitive to lifting and bending.

2. CONTENT OF THE BOX

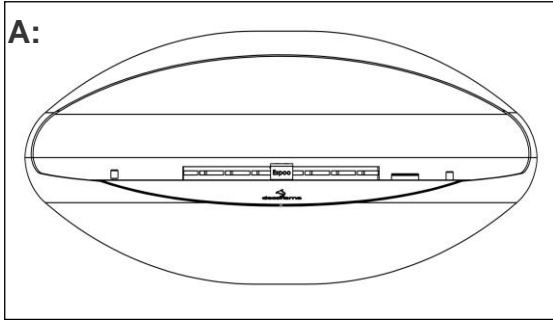

	Pcs.	Content
A:	1	Espoo Floor, Ignition button, Espoo logo plate
B:	1	B1: Floor telescope B2: Tripod with legs
C:	1	Pump
D:	1	Manual

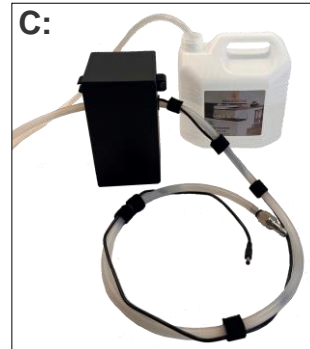
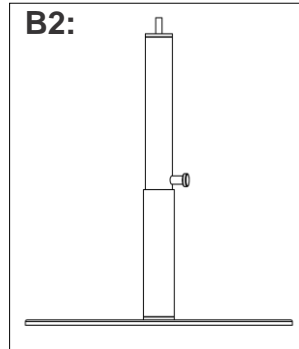
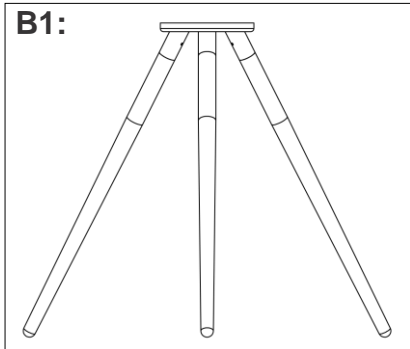

3. SAFETY

Naturally, safety is imperative dealing with open fire. All decoflame® fireplaces are designed, manufactured and quality-tested in Denmark with highest product safety and user-friendliness in mind. Our fireplaces feature a unique and design-protected decoflame® burner which is thoroughly tested and its closing mechanism manually adjusted prior to leaving the production line.

DO NOT amend, add or omit any parts or components of this fireplace as this will void your warranty. Please strictly adhere at all times to all safety measures and installation instructions described in this manual.



Do not fill fuel into the open flame



Do not fill fuel into the hot burner

ATTENTION

1	Chose a position for your fireplace which is not exposed to any draught, as bioethanol is a volatile fluid. In fact, only the vapors of the bioethanol are burning when lit.
2	Choose a solid floor surface, where it can hold the weight of the fireplace and base.
3	Avoid draughts, as this can cause soot formation and increases the fuel consumption.
4	Ensure that the room in which the fireplace is situated is well ventilated at all times during operation of your fireplace without causing any draught.
5	When lit - the metal of the burner and any glass parts of your fireplace can become hot during use. Avoid contact with those parts to prevent burning.
6	When lit, any glass screens will be warm, as the heat is led upwards. DO NOT place anything on top of your fireplace.
7	NEVER leave the fireplace unattended when it is lit.
8	For safety reasons always keep a safety distance of at least 400mm (16 in) from a lit fireplace.
9	ONLY adults may light and extinguish the flames.
10	You should not touch the flames of the lit fireplace or blow into the flames, as this will cause the flames to stand out from the fireplace and they will become uncontrollable. DO NOT touch the surface of the fireplace when lit.
11	When choosing a suitable position for your fireplace please also consider keeping it out of reach of smaller children and pets.
12	Do you have children or pets in the home? If so, make sure an adult keeps an eye on them at all times during operation of your fireplace and never leave your fireplace unattended during operation.
13	ALWAYS light and extinguish your DecoFlame® fireplace in a safe manner.
14	ALWAYS have a wet cloth/fireproof cloth and appropriate fire extinguisher nearby the fireplace.



4. POSITIONING & INSTALLATION

ESPOO Ø720x300mm

Heat efficiency:	1.3 - 2.6 kW/h
Weight:	37 kg
Burner volume:	2,4 liters of bioethanol. Only use bioethanol of at least 96.5% and max 97.5% for Decoflame® fireplaces.
Burning duration/consumption:	A full tank will last between 6-10 hours, depending on flame intensity and air flow.

The Espoo Floor model is primarily intended for indoors use. It can be positioned, however, on a balcony or terrace as well (it should not be kept exposed to the elements, though). Make sure that the fireplace stands on a solid floor with a distance of at least one meter (40 in) from curtains, sunshades and similar textiles or other inflammable objects.



Choose a position for the Espoo Floor before you light it. **DO NOT** move or lift the fireplace while it is lit.

Also, choose a position for your fireplace which is not exposed to any draught, as bioethanol is a volatile fuel. In fact, only the vapor of the bioethanol is burning when lit. You should not touch the flames of the lit fireplace or blow into the flames, as this will cause the flames to stand out from the fireplace and they will become uncontrollable.

DO NOT place any valuable paintings or electronic equipment like TV screens or speakers above the fireplace. The warm air from the fire will rise upwards and might damage anything in its way.



· fireplace into any niche, placed below a shelving or placed inside a very small room.

· pushed against a wall.

· conservatories only if their ambient temperature does never exceed normal room temperature.

· at least 40 cm from a lit fireplace.

DO NOT place anything on top of your fireplace.

Do you have children or pets in the home? If so, make sure an adult always keeps an eye on them during operation of your fireplace and never leave your fireplace unattended when it is lit.

If in doubt, please contact Decoflame.

INSTALLATION (only for ESPOO)

4. POSITIONING & INSTALLATION

INSTALLATION (using tripod)

Installation of base & Espoo fireplace
(best done by two people)

1. Insert the wooden legs in the tripod flange, and make sure that you have pushed them all the way in.
2. Fix the wooden leg by screwing three screws (nr. 3) into the holes on pipes under the tripod.
3. Now you have completed the assembly of the tripod & legs, you should bring it to standing position, and then put the fireplace on top and locate the hole for M10 under the fireplace,
4. As last step you need to screw the M10 bolt (nr. 4) under the fireplace and fasten it.

Attention!

Please check for any loose connections.

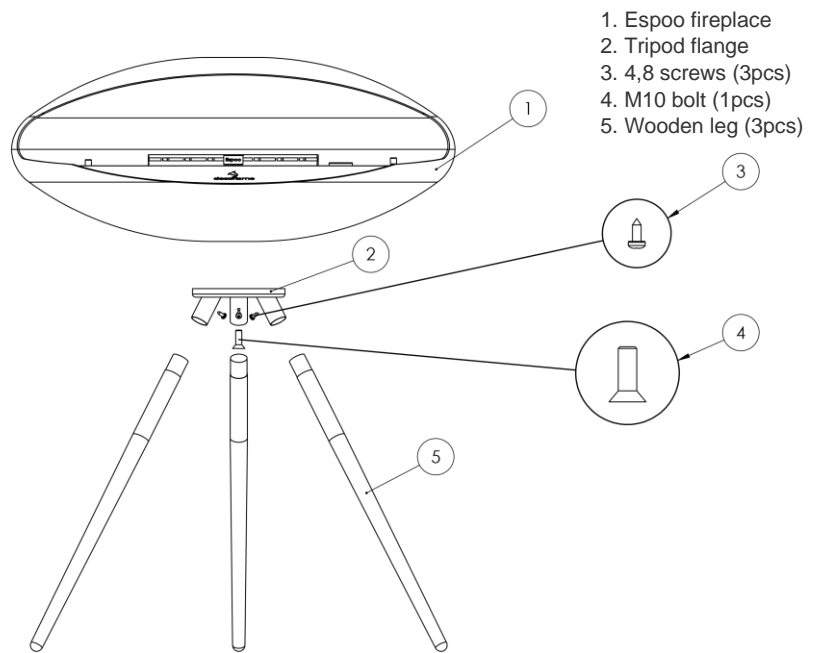

INSTALLATION (using telescope)

Installation of base & Espoo fireplace
(best done by two people)

1. Fix the floor telescope (nr. 2) to the base flange (nr. 4) using the three M6 bolts (nr. 4).
2. Screw the assembly of the flange & telescope under the fireplace and fasten it.

Attention!

Please check for any loose connections.

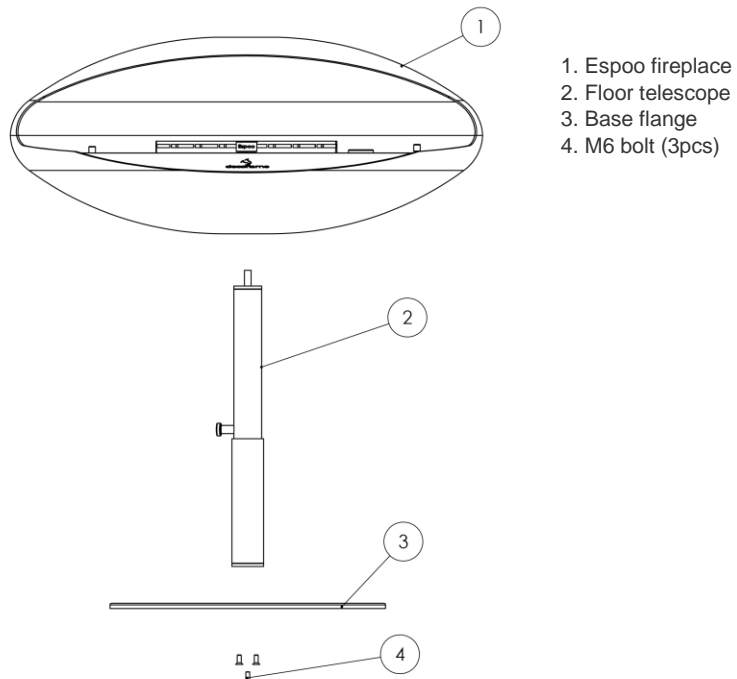

5. OPERATING INSTRUCTIONS

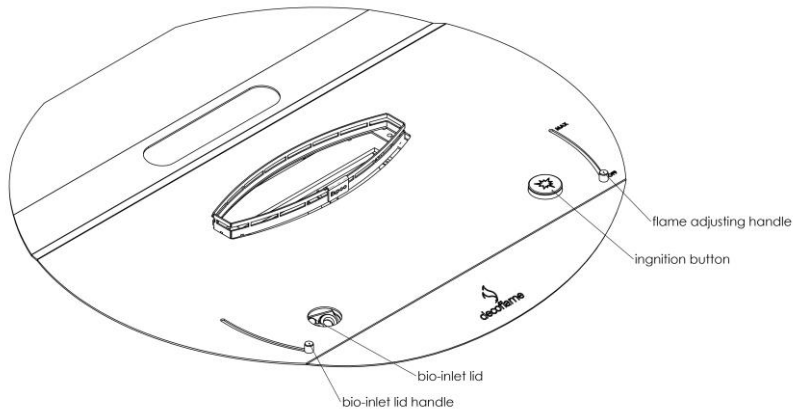

Espoo Floor is designed and manufactured exclusively for use with liquid bioethanol of the highest purity (96.5 - 97.5%) without additives. **DO NOT** use other fuel, material or bioethanol of inferior quality, as the warranty will be void. The model is equipped with a filling pump to avoid spillage or overflow of bio during the filling process.

FILLING

The fireplace must **ONLY** be filled when it is cold! To increase safety, this model is equipped with a temperature sensor, thus, the pump does not start when the fireplace is hot or in operation.

Buy the bioethanol online or at Decoflame dealers. Make sure it is mine. 96.5% and max. 97.5% and without additives. It is recommended to buy a 3-liter bioethanol canister as indicated to the right.

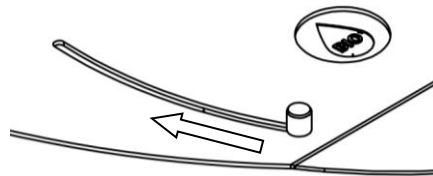

1. Open the fuel tank cover using the handle on the left side and push it towards the burner as shown above.
2. Open a can of bioethanol. Place the hose without quick coupling into the can.
3. The hose with the quick coupling is led up to the fireplace's tank filling.
4. Push the quick coupling until it clicks and until it is locked.
5. When both hoses are positioned correctly, the plug can be inserted. When the plug is in place, the pump starts to fill.



stick

quick-release coupling

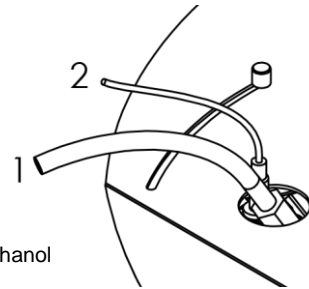

Wait until the tank is full. The fireplace is equipped with a sensor which cuts off the pump, when the bioethanol reaches a certain level in the tank. This mechanism controls the risk of overfilling the tank.

IMPORTANT The sequence must be followed as shown in the picture.

The coupling must always be connected first. Then insert the plug.

OVERFILLING

A fault in the pump or sensors can lead to overfilling the tank.

It is important to check the bottom of the fireplace for bioethanol. The small hole under the fireplace ensures that the bioethanol does not escape in the event of overfilling.

DO NOT light the fireplace if you have overfilled it!

It is recommended to use a 3-liter canister. In case of overfilling, use a piece of paper towel to wipe up excess bioethanol on the burner, the surrounding surfaces and the bottom of the fireplace. Wait 24 hours before starting the fireplace again. If the error occurs again, the fireplace must not be used. In this case, you must immediately contact Decoflame's Service Department for further instructions.

6. MAINTENANCE

REFILLING

Under no circumstances refill the burner while it is in operation or still hot from previous use. For safety reasons, this fireplace is equipped with a temperature sensor that prevents the pump from filling when the fireplace is hot. Man Wait 20-30 minutes before the fireplace has cooled down. It is then ready for refilling.

1. Once pump stopped, stick should be unplugged first, and then coupling can be released by pushing the black round button.

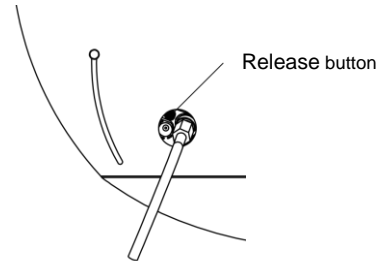

2. Due to safety reasons, fuel inlet lid should be moved back to closed position as shown in the picture.

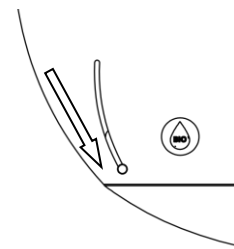

IGNITION

To light the fireplace, the handle (on the right side) for adjusting the fire must be placed in the "MAX" position. Espoo Ceiling is equipped with an easy ignition system:

When the adjustment handle is in the "MAX" position, the fireplace can be lit using the ignition button.

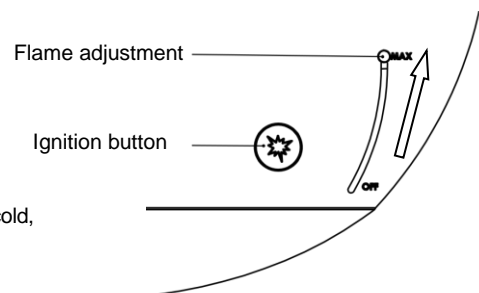

IMPORTANT

The bioethanol must be at room temperature before it can be ignited. If the bioethanol is very cold, or the room temperature is too low, you can use a lighter to ignite the fireplace.

It will take approx. 10-20 minutes before the flames reach the intended size.

DO NOT attempt to extinguish the fire during this period.

When the fireplace is started on a full tank, it will take approx. 6-10 hours before all the fuel in the tank is burnt out.

The adjustment lever on the right side can be used to adjust the flame level. The closer to "MAX", the higher the flames.

The closer to the "OFF" position, the lower the flames.

POWER OFF

If it is necessary to extinguish the fire before the burner is empty, put the adjustment lever in the middle position between "MAX" and "OFF". Then wait 1 minute before turning off the flame completely. After 1 minute, move the adjustment lever to the "OFF" position. The fire should be extinguished immediately. See the image below.

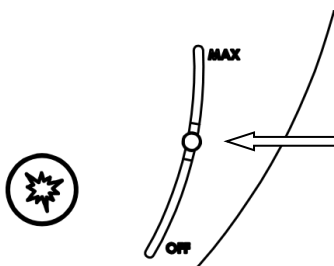

Step 1: hold in mid-position for 60 seconds.

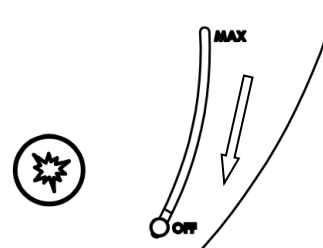

Step 2: extinguish the fire by moving the arm to off position.

PUMP

The Espoo Ceiling contains a pump to fill the tank. The pump is battery powered. It is important to check when the battery is discharged. The battery must be replaced with a new one. Depending on the type and brand of the battery, it lasts for approx. 20-30 refills. The pump's 9V battery must be replaced as indicated below:

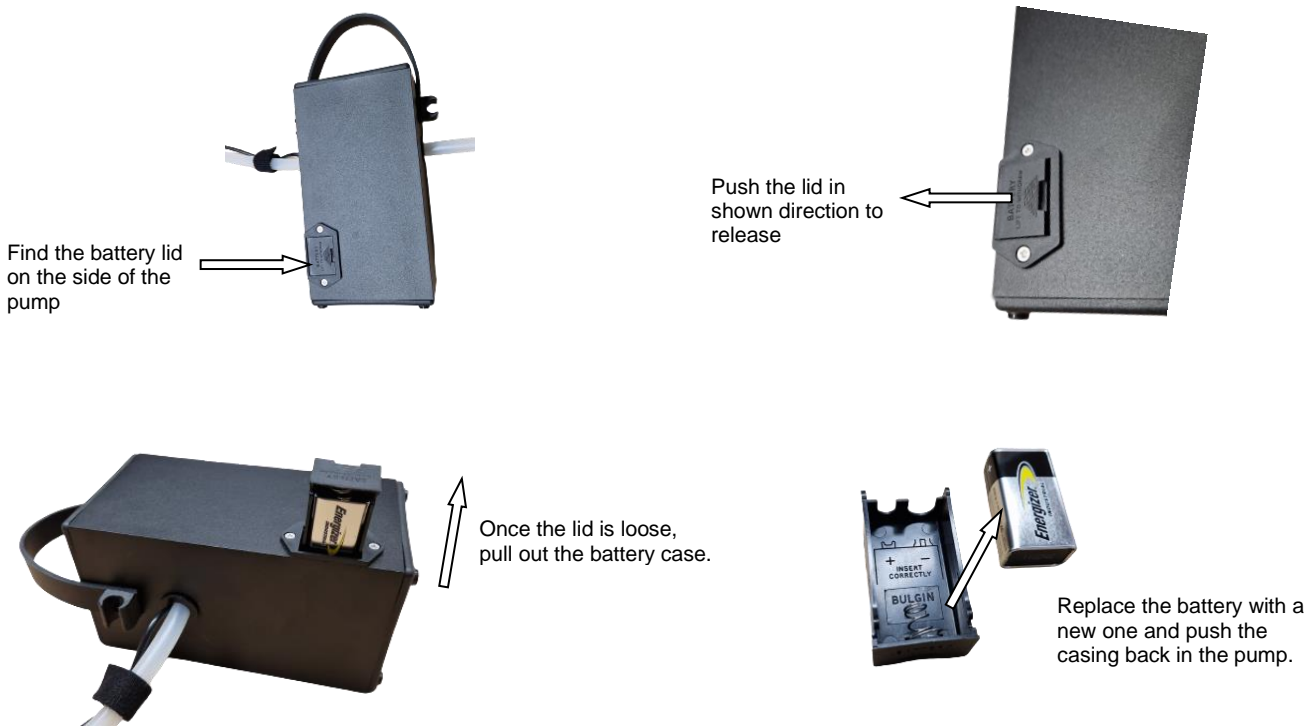

IGNITION SYSTEM

To increase safety, the fireplace is equipped with an ignition system that ignites the flames. It is important to note that the ignition system only works if the bioethanol and the fireplace are at room temperature. This ignition system uses a AAA battery to generate sparks. Depending on the battery type, it should last for at least 5-6 months. In case of low battery, replace the battery as indicated below:

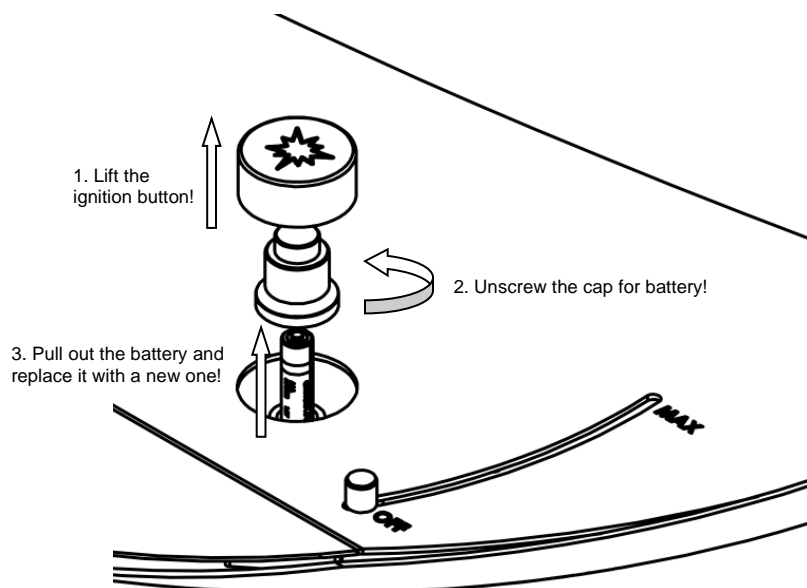

After replacing battery, screw back the cap and put the ignition button on top.

7. DISPOSAL AND RECYCLING

The fireplace is made of powder-coated steel and brushed steel. If you wish to dispose of the fireplace, the regional rules and regulations must be observed. Most parts from the Decoflame fireplace can be reused.

8. BIOETHANOL

Buy bioethanol from a dealer or online and make sure the alcohol percentage is min. 96.5% - max. 97.5%.
BIOETHANOL IS EXTREMELY FLAMMABLE!

Storing conditions

Always thoroughly follow the instructions on the packaging of the bioethanol. The bioethanol must be stored safely and out of the reach of children!
 Only store in original and correctly labeled containers. Keep containers tightly closed. Store in a cool, dry and ventilated room away from ignition sources, oxidizers and non-compliant materials. Provide preventive measures against the generation of static charge. The bioethanol must be at room temperature before it can be ignited.

Safety measures

Preventive measures: Avoid inhalation of vapors. Avoid contact with eyes, skin and clothing. Persons who are prone to skin allergies or lung disease should not come into contact with bioethanol. We recommend that people with breathing problems or asthma keep a window opened during the use of their bioethanol fireplace. Use standard precautions for working with chemicals.

Measures to prevent fire

Due to the high flammability of the product strictly follow the special fire protection measures at the storage location. Protect containers from overheating. Bioethanol should be stored in a fireproof container and out of the reach of children. Prevent bioethanol from coming in contact with heat, sparks and flames. Keep away from non-compliant materials such as metal or alkali. Flash point 13°C / boiling point 78°C. The fireplace can be difficult to start, if it is below room temperature.

DO NOT

1	DO NOT use any other fuel, materials or bioethanol of inferior quality as this will void your guaranty.
2	DO NOT use any sentences or oils to your bioethanol as this will void your guaranty.
3	DO NOT mix bioethanol with other fuels as this will void your guaranty.

Denatured Bioethanol is classified as:
 Flammable Liquid Class 1B (for Flammability)
 Class 3 PGII (for Transportation)UN1170
 (Identification Code) Regulated by various standards around the world.

You must familiarize yourself and comply with these regulations in order to safely and legally store, handle, decant and use this fuel.



ATTENTION BIOETHANOL

1	DO NOT light the bioethanol if you have overfilled the burner.
2	DO NOT fill the burner with bioethanol until the temperature is below 40 degrees Celsius.
3	DO NOT smoke when filling the burner with bioethanol.
4	DO NOT refill the fireplace during operation or if it is still hot from previous use.
5	DO NOT attempt to blow out the fire - or blow into the flames, as this will cause the flames to escape from the fireplace and they will be uncontrollable.
6	DO NOT cover the fireplace when it is under fire or if it is hot.
7	DO NOT place any inflammable materials or clothes on the fireplace.
8	DO NOT place anything on top of the fireplace.
9	DO NOT decorate the burner with ceramic pebbles or other items as this will lead to overheating and damage to the glass surround.
10	DO NOT place any pebbles or stones on the burner as these will crack and might cause injury or damage to the fireplace.
11	DO NOT place any ceramic logs or pebbles on top of the burner as these will increase the combustion temperature, which increases the fuel consumption and might cause undesired micro-particles in the room air.
12	DO NOT place any valuable paintings or electronic equipment like TV screens or speakers above the fireplace. The warm air from the fire will rise upwards and might damage surrounding material.
13	DO NOT use the burner as a barbecue!
14	DO NOT touch the flames.



9. SYMBOLS OF AWARENES



Do not fill fuel into the open flame



Do not fill fuel into The hot burner



Do not touch the flames



Health hazard



Do not position the fireplace near combustible items



Protect fireplace against draft



No smoking



Never fan the fire



Keep suitable extinguishing agent ready.

Warning – flammable material



Adhere to instructions about fuel and fire blanket.



The package will include:

	Pcs.	Content	
A:	1	Espoo Floor: Ignition button Espoo logo plate M10 bolt	
B:	1	B1: Floor telescope B2: Tripod with legs	
C:	1	Pump	
D:	1	Manual	

Rating plate:

Decoflame ApS

Date

*Follow the Fire Authorities and national and local requirements regarding bioethanol fireplaces.
Subject to typographical errors and technical errors. Decoflame ApS reserves the right to make changes without notice.
We refer to Decoflame's General Terms of Sale and Delivery.
V10723*

Decoflame ApS | Vang Mark 2, 9380 Vestbjerg, DK | +45 9630 4800 | info@decoflame.dk