

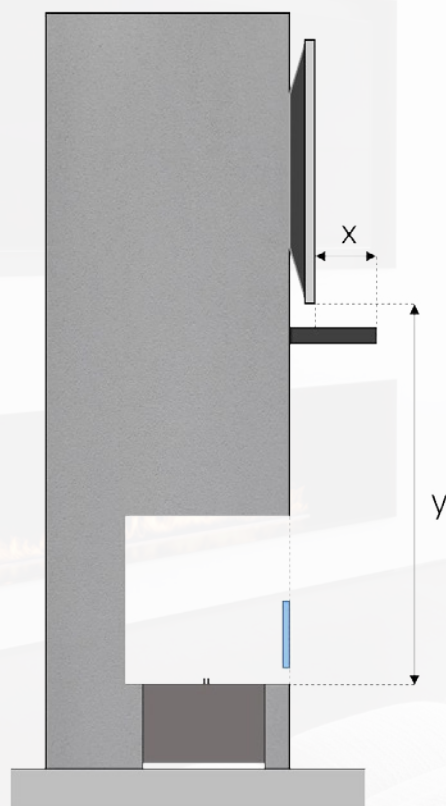

**MONTAGE GUIDE**  
**TV & BIO FIREPLACE**  
**INSTALLATION**

# OPTION 1



		y
x	0-50 mm	min 1110 mm
	51-100 mm	min 1000 mm
	>=101 mm	min 900 mm

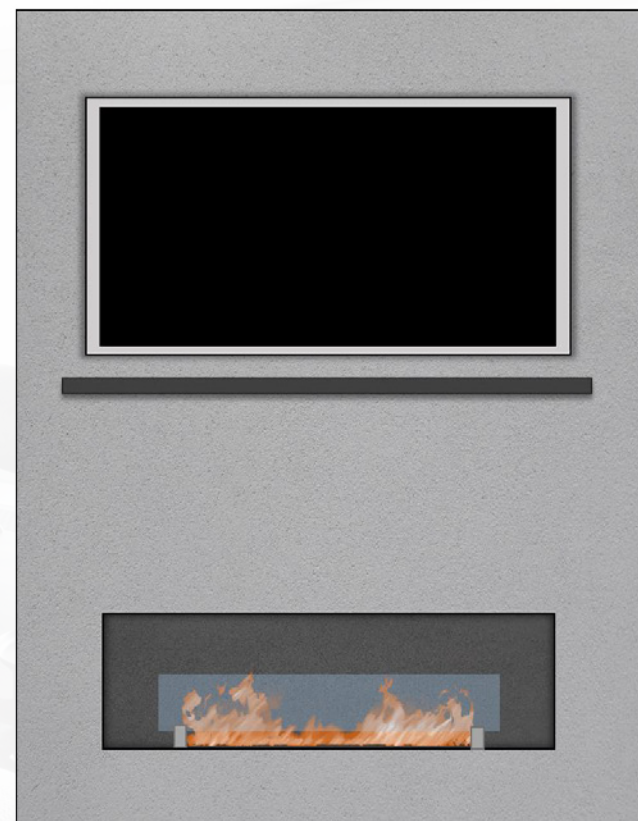

# OPTION 2

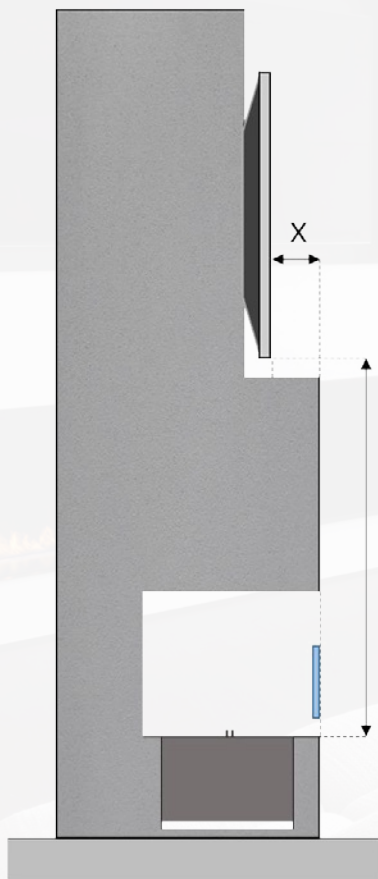

		<b>y</b>
<b>x</b>	0-50 mm	min 1110 mm
	51-100 mm	min 1000 mm
	>=101 mm	min 900 mm



# OPTION 3

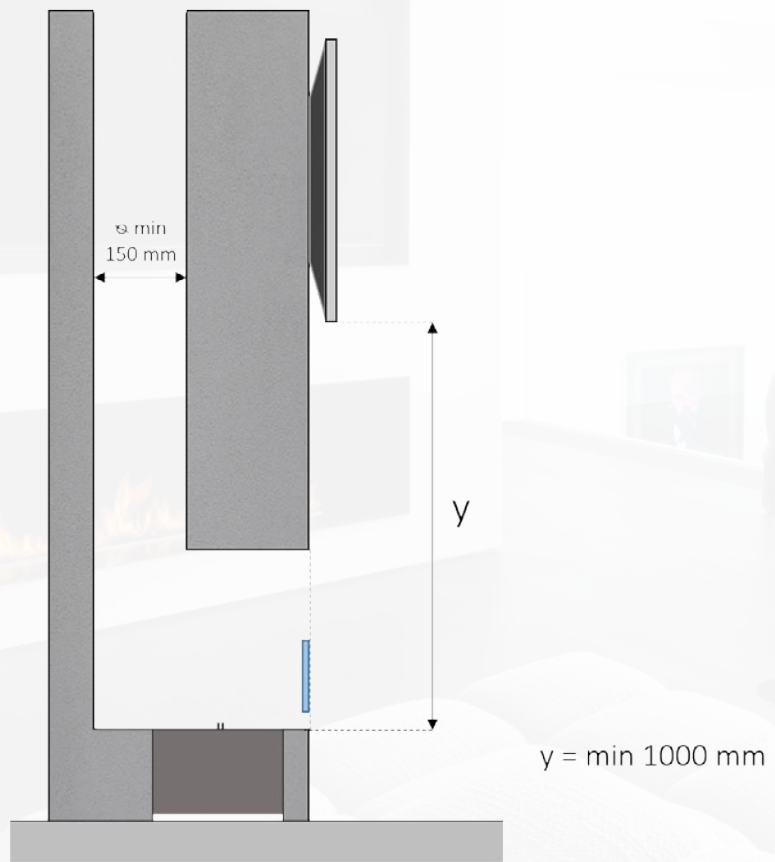

# OPTION 4

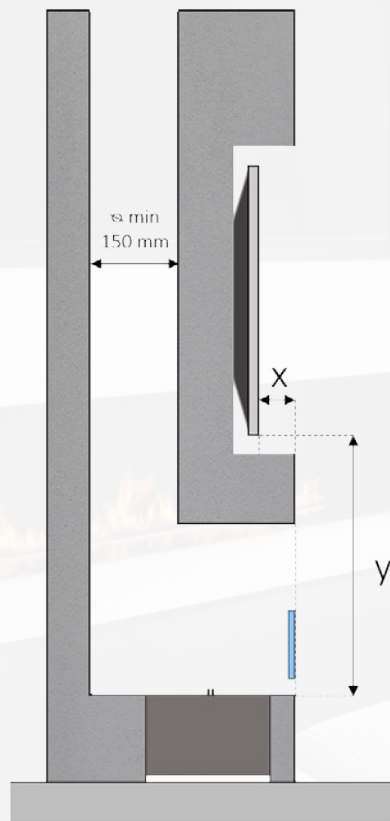

		y
x	0-50 mm	min 800 mm
	51-100 mm	min 700 mm
	$\geq$ 101 mm	min 600 mm

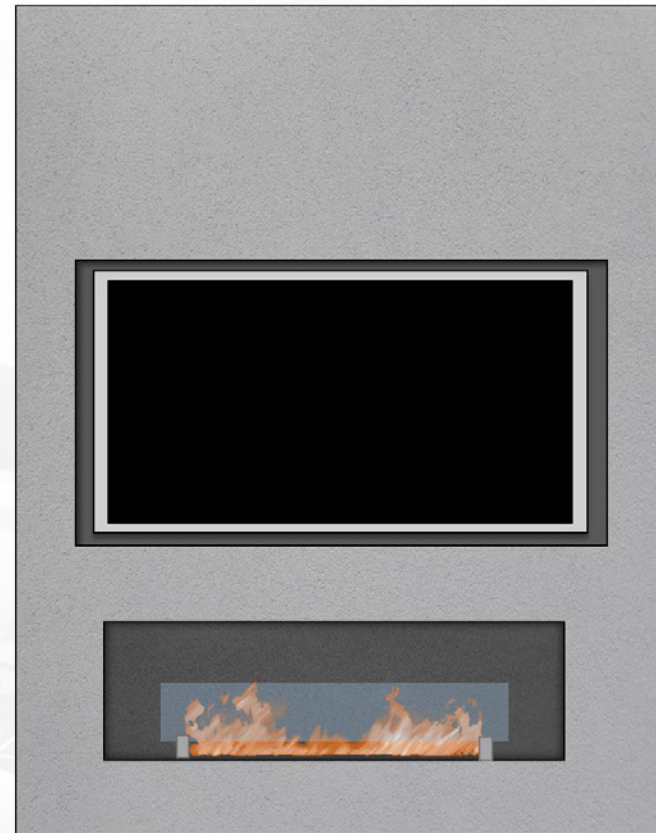

# OPTION 5

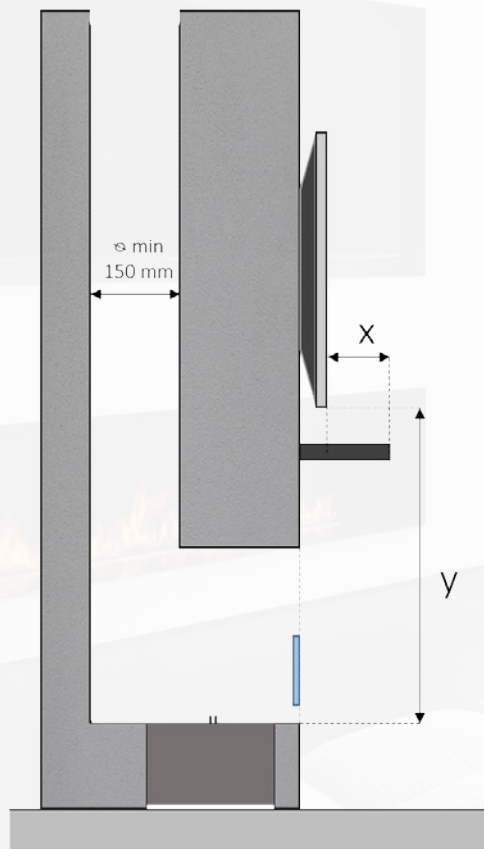

		Y
X	0-50 mm	min 800 mm
	51-100 mm	min 700 mm
	>-101 mm	min 600 mm

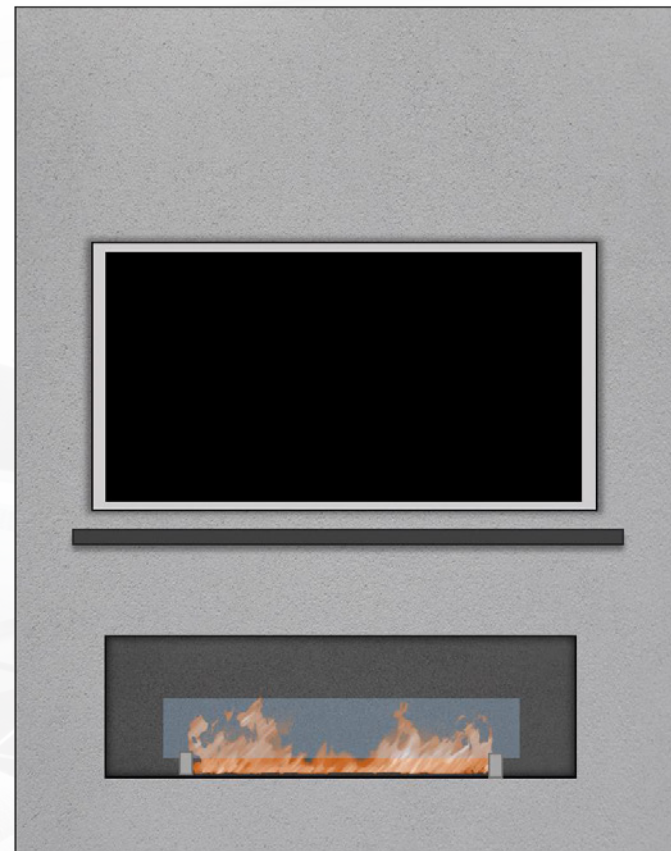



[www.biofireplacegroup.com](http://www.biofireplacegroup.com)